

**EAT•N**

**Hydraulics**

**Swivel Joints**



# Table of Contents

<b>Advantages of using Eaton Swivel Joints</b> _____	<b>2</b>
<b>Selection Criteria and Product Safety Considerations</b> _____	<b>3</b>
<b>FS6500</b> _____	<b>4</b>
Features and Benefits _____	4
Performance Testing _____	4
Repair Kit _____	10
<b>BD5500</b> _____	<b>11</b>
Repair Kit _____	14
<b>FS5900</b> _____	<b>15</b>
Repair Kit _____	17

## Swivel Joints Advantages

### 1. Better System Plumbing:

- A. Because less hose is needed when swivel joints are used, the system is more space efficient (Figure 1).
- B. Swivel joints can eliminate the need for tubing configurations to accommodate 90° and other angles.
- C. Swivel joints can be directly connected to hose lines frequently eliminating the need for adapters.

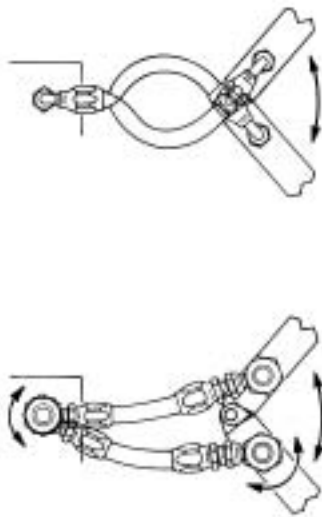

Figure 1

### 2. Prevent Hose Twisting and Kinking:

Because of the swivel action, swivel joints prevent hose twisting and kinking (Figure 2 & 3).

### 3. Less Downtime:

With the problem of hose twisting and kinking eliminated, hose line replacement becomes significantly less

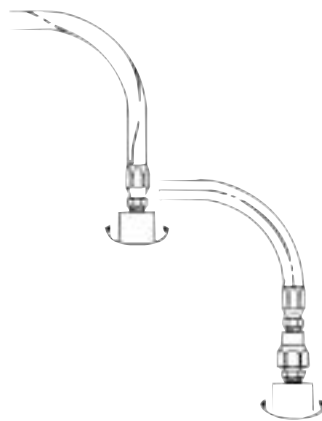

Figure 2

### 4. Absorb System Shock:

Swivel joints are not rigid and therefore capable of absorbing some hose shortening when the system is pressurized.

### 5. Save Money:

Less hose, fewer adapters and tubing configurations and less downtime add up to saving money when swivel joints are used.

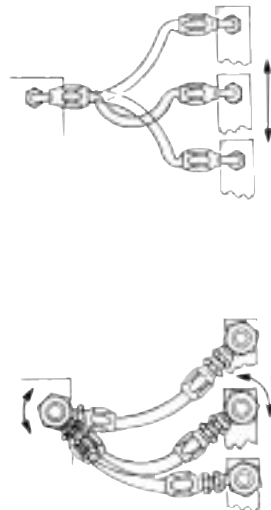

Figure 3

### Features:

- Balanced-pressure design
- Low-drop dimensions
- Contamination seals
- 360-degree rotation
- Standard o-ring design

### Benefits:

- Show no significant increase in torque with introduction of pressure
- Fit in compact areas
- Prevent environmental contaminants from entering the swivel joints
- Prevent hose twisting, thus increasing hose life
- Allow quick and reliable field repairs

# Swivel Joints

## Selection Criteria and Product Safety Considerations

Many variables are involved in the application and selection of industrial swivel joints in a fluid power system. Careful consideration must be paid to each of the criteria listed below to achieve optimum efficiency from a swivel joint.

### 1. Pressure:

This is a force or thrust applied on the surface of a fluid carrying vehicle. System operating pressure must not exceed the rating of the swivel joint.

### 2. Temperature:

Both internal and ambient temperatures are important in proper swivel joint functioning. Internally, the temperature rating is determined by the seals. If the fluid is too hot, the seals will deteriorate and the swivel joint will leak and resist rotation. Externally, too high a temperature will damage the casing and seals causing similar problems. When selecting seals, always insure they meet the required temperature ranges.

### 3. Fluid Compatibility:

An important consideration in determining which joint and seal material to use is their compatibility with the agent to be conveyed in the system. Internal swivel joint components that are not suitable for the fluid being carried in the system will be severely damaged. Carefully check the fluid compatibility.

### 4. Cost:

Cost, of course, is an important consideration. However, the initial cost of a swivel joint can be more than offset by cost reduction benefits such as an improved system routing with less hose, fewer adapters and tube fittings and longer service life.

### 5. Side Loading:

Defined as the stress caused by angular deflection in a piping system, side loading causes excessive wear on the bearing surfaces and inhibits smooth swivel joint operation. Care must be taken when plumbing a system with swivel joints to avoid stress situations.

### 6. Pressure Drop:

This is the resistance to the flow of the agent through the swivel joint measured in pounds per square inch (psi). The higher the resistance to flow, the greater the loss of efficiency. Eaton swivel joints have been designed for minimal resistance to flow.

### 7. Torque:

Defined as the force that produces a rotation, torque is an important consideration when specifying swivel joints. Eaton swivel joints rotate freely with low torque even under pressures up to 10,000 psi. This permits consistent, trouble-free service.

### 8. Configurations:

The swivel joint configuration specified (straight or 90°) is determined by such factors as available space and system routing. Make sure the swivel joint configuration and envelope dimensions allow freedom of movement while maintaining compatibility with the system's routing.

### 9. Port Size:

Using the right port size and thread is a significant factor in the proper selection of a swivel joint. The port size and thread must match that of the end fitting on the connecting hose line.

### 10. Corrosion Resistance:

Make sure the environment in which the swivel joint works and the fluid carried are free of corrosive elements which could severely limit service life.

### 11. Rotation:

Rotation must be easy and unrestricted for proper service of the swivel joint. The joint and the connecting line must be allowed to rotate freely for optimum performance.

# Swivel Joints

## FS65

FS65 Balanced-Pressure Series Swivel Joints answer customer requests for a more cost competitive, compact product.

FS65 Series Swivel Joints feature compact forged casings. Their balanced-pressure design distributes pressure evenly through the body of the joints, eliminating axial loading of the sleeve. This allows the swivel joints to rotate with very low torque—even up to their fully rated operating pressure.

The FS65 is available in sizes 1/4 - inch to 1 - inch. The swivel joints have pressure capabilities up to 5,000 psi for the 1/4-inch and 3/8-inch sizes; 3,500 psi for the 1/2-inch, 5/8-inch, and 3/4-inch sizes; and 3,000 psi for the 1-inch size.

### How to Order

When ordering a swivel joint, follow these steps:

1. State the base part number, casing and sleeve port size, as shown.
2. Add the suffix code which indicates the seal required, as shown in the seal chart at right.

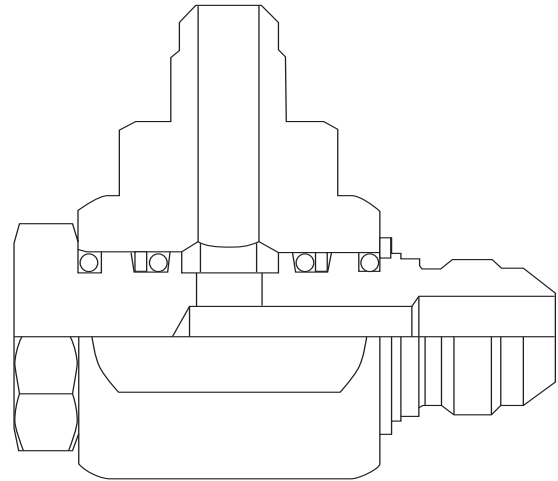
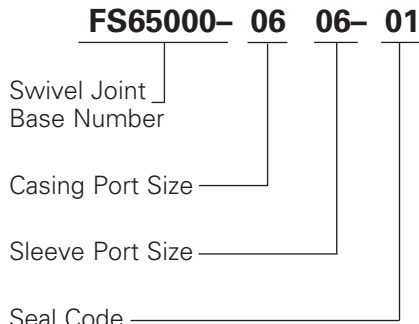

### Seal Material Options

SEAL CODE	MATERIAL	DESCRIPTION	APPLICATION
-01	Buna-N	O-Ring Seal	Hydraulic Oils, Water Glycol
-04	EPR	O-Ring Seal	Brake Fluids, Water, Phosphate Ester, Alcohols
-06	Viton™	O-Ring Seal	Chemicals, Gasoline, Aromatic Solvents

Viton is a registered trademark of E.I. DuPont.

### Torque vs. Pressure

FS65 Series Swivel Joints perform best in class when it comes to side-load testing, while impulsing at 133 percent of maximum operating pressure—and rotating through a 120-degree angular sweep forward and in reverse.

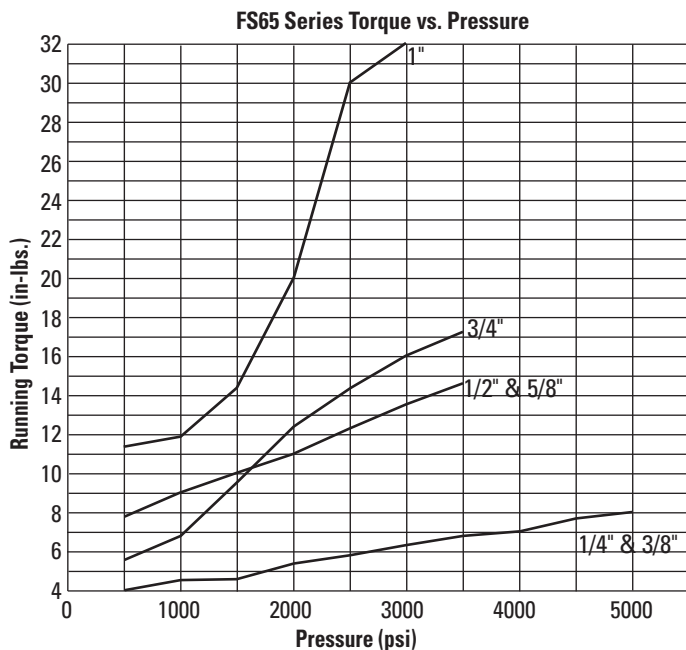

### Pressure Drop vs Flow

FS65 Series Swivel Joints passed the minimum requirements of 150,000 cycles for the 1/4-inch and 3/8-inch nominal sizes, and 200,000 cycles for the 1/2-inch through 1-inch sizes, while measuring zero leakage per SAE J1176.

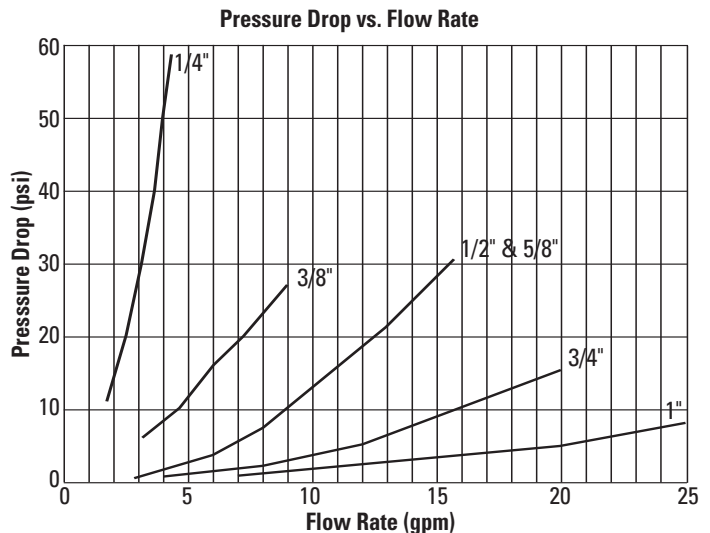

### Pressure Rating for FS65 Series

SWIVEL SIZE	OPERATING PRESSURE (PSI)	SWIVEL SIZE	OPERATING PRESSURE (PSI)
1/4"	5000	5/8"	3500
3/8"	5000	3/4"	3500
1/2"	3500	1"	3000

### Male Pipe x Male Pipe

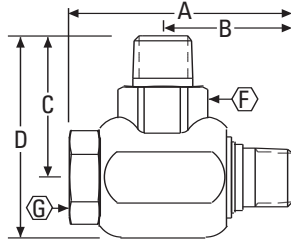

PART NUMBER	SWIVEL SIZE	CASING THREAD	SLEEVE THREAD	A	B	C	D	(F)	(G)
FS65006-0404-01	1/4	1/4-18 NPTF	1/4-18 NPTF	2.60	1.49	1.60	2.29	24 mm	15/16
FS65006-0606-01	3/8	3/8-18 NPTF	3/8-18 NPTF	2.53	1.48	1.62	2.31	24 mm	15/16
FS65006-0808-01	1/2	1/2-14 NPTF	1/2-14 NPTF	2.88	1.54	1.89	2.66	29 mm	1
FS65006-1212-01	3/4	3/4-14 NPTF	3/4-14 NPTF	3.21	1.89	2.30	3.25	34 mm	1-1/4
FS65006-1616-01	1	1-11 1/2 NPTF	1-11 1/2 NPTF	3.91	2.27	2.60	3.68	43 mm	1-5/8

### Male Pipe x Female Pipe

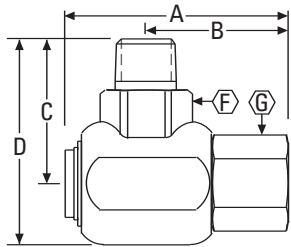

PART NUMBER	SWIVEL SIZE	CASING THREAD	SLEEVE THREAD	A	B	C	D	(F)	(G)
FS65015-0404-01	1/4	1/4-18 NPTF	1/4-18 NPTF	2.49	1.59	1.66	2.35	24 mm	15/16
FS65015-0606-01	3/8	3/8-18 NPTF	3/8-18 NPTF	2.49	1.58	1.62	2.31	24 mm	15/16
FS65015-0808-01	1/2	1/2-14 NPTF	1/2-14 NPTF	3.14	1.97	1.62	2.39	29 mm	1-1/16
FS65015-1212-01	3/4	3/4-14 NPTF	3/4-14 NPTF	3.21	2.08	2.30	3.25	34 mm	1-5/16
FS65015-1616-01	1	1-11 1/2 NPTF	1-11 1/2 NPTF	3.84	2.53	2.60	3.68	43 mm	1-5/8

### Male Pipe x Male SAE 37°

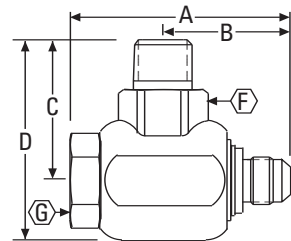

PART NUMBER	SWIVEL SIZE	CASING THREAD	SLEEVE THREAD	A	B	C	D	(F)	(G)
FS65019-0404-01	1/4	1/4-18 NPTF	7/16-20 UNF-2A	2.58	1.46	1.60	2.29	24 mm	15/16
FS65019-0606-01	3/8	3/8-18 NPTF	9/16-18 UNF-2A	2.51	1.46	1.62	2.31	24 mm	15/16
FS65019-0808-01	1/2	1/2-14 NPTF	3/4-16 UNF-2A	2.87	1.52	1.89	2.66	29 mm	1
FS65019-1212-01	3/4	3/4-14 NPTF	1 1/16-12 UN-2A	3.31	1.99	2.30	3.25	34 mm	1-1/4
FS65019-1616-01	1	1-11 1/2 NPTF	1 5/16-12 UN-2A	3.86	2.23	2.60	3.68	43 mm	1-5/8

### Male Pipe x Male SAE O-Ring Boss

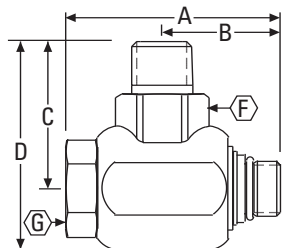

PART NUMBER	SWIVEL SIZE	CASING THREAD	SLEEVE THREAD	A	B	C	D	(F)	(G)
FS65022-0404-01	1/4	1/4-18 NPTF	7/16-20 UNF-2A	2.39	1.27	1.60	2.29	24 mm	15/16
FS65022-0606-01	3/8	3/8-18 NPTF	9/16-18 UNF-2A	2.35	1.30	1.62	2.31	24 mm	15/16
FS65022-0808-01	1/2	1/2-14 NPTF	3/4-16 UNF-2A	2.55	1.30	1.89	2.66	29 mm	1
FS65022-1212-01	3/4	3/4-14 NPTF	1 1/16-12 UN-2A	3.28	2.16	2.30	3.25	34 mm	1-1/4
FS65022-1616-01	1	1-11 1/2 NPTF	1 5/16-12 UN-2A	3.67	2.35	2.60	3.68	43 mm	1-5/8

### Female Pipe Swivel (NPSM) x Male Pipe

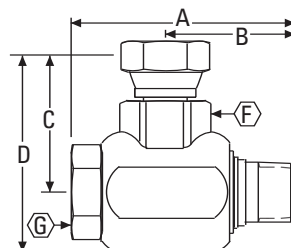

PART NUMBER	SWIVEL SIZE	CASING THREAD	SLEEVE THREAD	A	B	C	D	(F)	(G)
FS65000-0404-01	1/4	1/4-18 NPSM	1/4-18 NPTF	2.60	1.49	1.45	2.14	24 mm	15/16
FS65000-0606-01	3/8	3/8-18 NPSM	3/8-18 NPTF	2.53	1.48	1.45	2.14	24 mm	15/16
FS65000-0808-01	1/2	1/2-14 NPSM	1/2-14 NPTF	2.88	1.54	1.62	2.39	29 mm	1
FS65000-1212-01	3/4	3/4-14 NPSM	3/4-14 NPTF	3.21	1.89	2.14	3.09	34 mm	1-1/4
FS65000-1616-01	1	1-11 1/2 NPSM	1-11 1/2 NPTF	3.91	2.27	2.40	3.48	43 mm	1-5/8

**Female Pipe Swivel (NPSM)  
x Male SAE 37°**

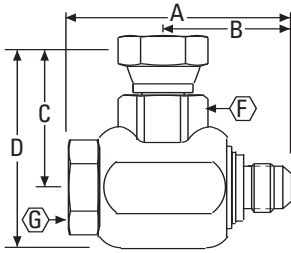

PART NUMBER	SWIVEL SIZE	CASING THREAD	SLEEVE THREAD	A	B	C	D	F	G
FS65001-0404-01	1/4	1/4-18 NPSM	7/16-20 UNF-2A	2.58	1.46	1.45	2.14	24 mm	15/16
FS65001-0606-01	3/8	3/8-18 NPSM	9/16-18 UNF-2A	2.51	1.46	1.45	2.14	24 mm	15/16
FS65001-0608-01	3/8	3/8-18 NPSM	3/4-16 UNF-2A	2.61	1.56	1.45	2.14	24 mm	15/16
FS65001-0808-01	1/2	1/2-14 NPSM	3/4-16 UNF-2A	2.77	1.52	1.62	2.39	29 mm	1
FS65001-0810-01	1/2	1/2-14 NPSM	7/8-14 UNF-2A	2.88	1.62	1.62	2.39	29 mm	1
FS65001-1212-01	3/4	3/4-14 NPSM	1 1/16-12 UN-2A	3.31	1.99	2.14	3.09	34 mm	1-1/4
FS65001-1616-01	1	1-11 1/2 NPSM	1 5/16-12 UN-2A	3.86	2.23	2.40	3.48	43 mm	1-5/8

**Female Pipe Swivel (NPSM)  
x Male SAE O-Ring Boss**

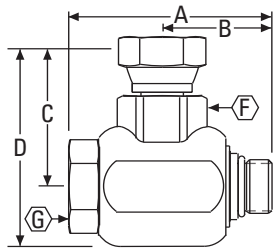

PART NUMBER	SWIVEL SIZE	CASING THREAD	SLEEVE THREAD	A	B	C	D	F	G
FS65002-0404-01	1/4	1/4-18 NPSM	7/16-20 UNF-2A	2.39	1.27	1.45	2.14	24 mm	15/16
FS65002-0405-01	1/4	1/4-18 NPSM	1/2-20 UNF-2A	2.39	1.27	1.45	2.14	24 mm	15/16
FS65002-0606-01	3/8	3/8-18 NPSM	9/16-18 UNF-2A	2.35	1.30	1.45	2.14	24 mm	15/16
FS65002-0608-01	3/8	3/8-18 NPSM	3/4-16 UNF-2A	2.65	1.74	1.45	2.14	24 mm	15/16
FS65002-0808-01	1/2	1/2-14 NPSM	3/4-16 UNF-2A	2.55	1.30	1.62	2.39	29 mm	1
FS65002-0810-01	1/2	1/2-14 NPSM	7/8-14 UNF-2A	2.55	1.36	1.62	2.39	29 mm	1-1/16
FS65002-1212-01	3/4	3/4-14 NPSM	1 1/16-12 UN-2A	3.28	2.16	2.14	3.09	34 mm	1-1/4
FS65002-1616-01	1	1-11 1/2 NPSM	1 5/16-12 UN-2A	3.67	2.35	2.40	3.48	43 mm	1-5/8

**Female Pipe Swivel (NPSM)  
x Female Pipe**

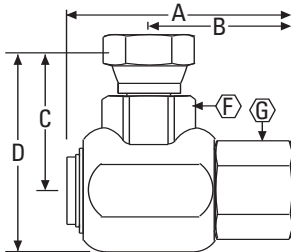

PART NUMBER	SWIVEL SIZE	CASING THREAD	SLEEVE THREAD	A	B	C	D	F	G
FS65005-0404-01	1/4	1/4-18 NPSM	1/4-18 NPTF	2.49	1.59	1.45	2.14	24 mm	15/16
FS65005-0606-01	3/8	3/8-18 NPSM	3/8-18 NPTF	2.49	1.58	1.45	2.14	24 mm	15/16
FS65005-0808-01	1/2	1/2-14 NPSM	1/2-14 NPTF	3.14	1.97	1.62	2.39	29 mm	1-1/16
FS65005-1212-01	3/4	3/4-14 NPSM	3/4-14 NPTF	3.21	2.08	2.14	3.09	34 mm	1-5/16
FS65005-1616-01	1	1-11 1/2 NPSM	1-11 1/2 NPTF	3.84	2.53	2.40	3.48	43 mm	1-5/8

**Female Pipe x Male Pipe**

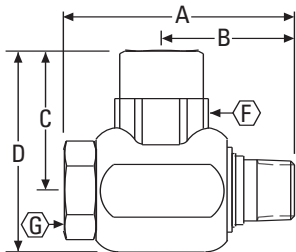

PART NUMBER	SWIVEL SIZE	CASING THREAD	SLEEVE THREAD	A	B	C	D	F	G
FS65007-0404-01	1/4	1/4-18 NPTF	1/4-18 NPTF	2.60	1.49	1.58	2.27	24 mm	15/16
FS65007-0606-01	3/8	3/8-18 NPTF	3/8-18 NPTF	2.53	1.48	1.59	2.28	24 mm	15/16
FS65007-0808-01	1/2	1/2-14 NPTF	1/2-14 NPTF	2.88	1.54	1.88	2.65	29 mm	1
FS65007-1212-01	3/4	3/4-14 NPTF	3/4-14 NPTF	3.21	1.89	2.30	3.25	34 mm	1-1/4
FS65007-1616-01	1	1-11 1/2 NPTF	1-11 1/2 NPTF	3.91	2.27	2.62	3.70	43 mm	1-5/8

**Female Pipe x Female Pipe**

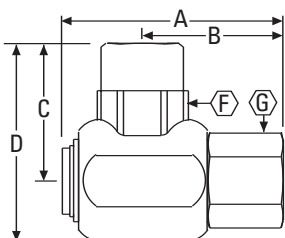

PART NUMBER	SWIVEL SIZE	CASING THREAD	SLEEVE THREAD	A	B	C	D	F	G
FS65008-0404-01	1/4	1/4-18 NPTF	1/4-18 NPTF	2.49	1.59	1.58	2.27	24 mm	15/16
FS65008-0606-01	3/8	3/8-18 NPTF	3/8-18 NPTF	2.49	1.58	1.59	2.28	24 mm	15/16
FS65008-0808-01	1/2	1/2-14 NPTF	1/2-14 NPTF	3.14	1.97	1.88	2.65	29 mm	1-1/16
FS65008-1212-01	3/4	3/4-14 NPTF	3/4-14 NPTF	3.21	2.08	2.30	3.25	34 mm	1-5/16
FS65008-1616-01	1	1-11 1/2 NPTF	1-11 1/2 NPTF	3.84	2.53	2.62	3.70	43 mm	1-5/8



### Female Pipe x Male SAE 37°

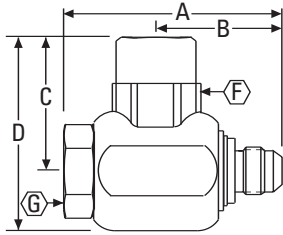

PART NUMBER	SWIVEL SIZE	CASING THREAD	SLEEVE THREAD	A	B	C	D	F	G
FS65010-0404-01	1/4	1/4-18 NPTF	7/16-20 UNF-2A	2.58	1.46	1.58	2.27	24 mm	15/16
FS65010-0405-01	1/4	1/4-18 NPTF	1/2-20 UNF-2A	2.58	1.46	1.58	2.27	24 mm	15/16
FS65010-0606-01	3/8	3/8-18 NPTF	9/16-18 UNF-2A	2.51	1.46	1.59	2.28	24 mm	15/16
FS65010-0808-01	1/2	1/2-14 NPTF	3/4-16 UNF-2A	2.77	1.52	1.88	2.65	29 mm	1
FS65010-1212-01	3/4	3/4-14 NPTF	1 1/16-12 UN-2A	3.31	1.99	2.30	3.25	34 mm	1-1/4
FS65010-1616-01	1	1-11 1/2 NPTF	1 5/16-12 UN-2A	3.86	2.23	2.62	3.70	43 mm	1-5/8

### Female Pipe x Male SAE O-Ring Boss

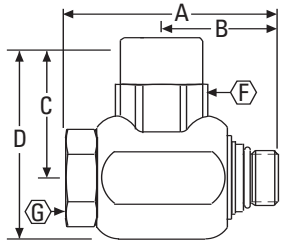

PART NUMBER	SWIVEL SIZE	CASING THREAD	SLEEVE THREAD	A	B	C	D	F	G
FS65011-0404-01	1/4	1/4-18 NPTF	7/16-20 UNF-2A	2.39	1.27	1.58	2.27	24 mm	15/16
FS65011-0405-01	1/4	1/4-18 NPTF	1/2-20 UNF-2A	2.39	1.27	1.58	2.27	24 mm	15/16
FS65011-0606-01	3/8	3/8-18 NPTF	9/16-18 UNF-2A	2.35	1.30	1.59	2.28	24 mm	15/16
FS65011-0808-01	1/2	1/2-14 NPTF	3/4-16 UNF-2A	2.55	1.30	1.88	2.65	29 mm	1
FS65011-0810-01	1/2	1/2-14 NPTF	7/8-14 UNF-2A	2.88	1.36	1.88	2.65	29 mm	1-1/16
FS65011-1212-01	3/4	3/4-14 NPTF	1 1/16-12 UN-2A	3.28	2.16	2.30	3.25	34 mm	1-1/4
FS65011-1616-01	1	1-11 1/2 NPTF	1 5/16-12 UN-2A	3.67	2.35	2.62	3.70	43 mm	1-5/8

### Male SAE 37° x Male Pipe

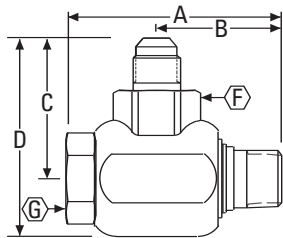

PART NUMBER	SWIVEL SIZE	CASING THREAD	SLEEVE THREAD	A	B	C	D	F	G
FS65003-0404-01	1/4	7/16-20 UNF-2A	1/4-18 NPTF	2.60	1.49	1.66	2.35	24 mm	15/16
FS65003-0504-01	1/4	1/2-20 UNF-2A	1/4-18 NPTF	2.60	1.49	1.66	2.35	24 mm	15/16
FS65003-0606-01	3/8	9/16-18 UNF-2A	9/16-18 NPTF	2.53	1.48	1.67	2.36	24 mm	15/16
FS65003-0806-01	3/8	3/4-16 UNF-2A	3/4-16 NPTF	2.53	1.58	1.77	2.46	24 mm	15/16
FS65003-0808-01	1/2	3/4-16 UNF-2A	1/2-14 NPTF	2.88	1.54	1.89	2.66	29 mm	1
FS65003-1008-01	1/2	7/8-14 UNF-2A	1/2-14 NPTF	2.88	1.54	2.00	2.77	29 mm	1
FS65003-1212-01	3/4	1 1/16-12 UN-2A	3/4-14 NPTF	3.21	1.89	2.36	3.31	34 mm	1-1/4
FS65003-1616-01	1	1 5/16-12 UN-2A	1-11 1/2 NPTF	3.91	2.27	2.60	3.68	43 mm	1-5/8

### Male SAE 37° x Male SAE 37°

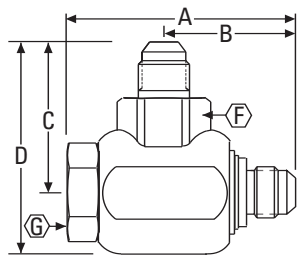

PART NUMBER	SWIVEL SIZE	CASING THREAD	SLEEVE THREAD	A	B	C	D	F	G
FS65004-0404-01	1/4	7/16-20 UNF-2A	7/16-20 UNF-2A	2.56	1.46	1.66	2.35	24 mm	15/16
FS65004-0505-01	1/4	1/2-20 UNF-2A	1/2-20 UNF-2A	2.56	1.46	1.66	2.35	24 mm	15/16
FS65004-0606-01	3/8	9/16-18 UNF-2A	9/16-18 UNF-2A	2.51	1.46	1.67	2.36	24 mm	15/16
FS65004-0808-01	3/8	3/4-16 UNF-2A	3/4-16 UNF-2A	2.61	1.56	1.77	2.46	24 mm	15/16
FS65004-1010-01	5/8	7/8-14 UNF-2A	7/8-14 UNF-2A	2.87	1.62	2.00	2.77	29 mm	1
FS65004-1212-01	3/4	1 1/16-12 UN-2A	1 1/16-12 UN-2A	3.31	1.99	2.36	3.31	34 mm	1-1/4
FS65004-1616-01	1	1 5/16-12 UN-2A	1 5/16-12 UN-2A	3.86	2.23	2.60	3.68	43 mm	1-5/8

### Male SAE 37° x Male SAE O-Ring Boss

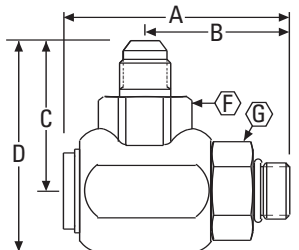

PART NUMBER	SWIVEL SIZE	CASING THREAD	SLEEVE THREAD	A	B	C	D	F	G
FS65009-0404-01	1/4	7/16-20 UNF-2A	7/16-20 UNF-2A	2.39	1.27	1.66	2.35	24 mm	15/16
FS65009-0505-01	1/4	1/2-20 UNF-2A	1/2-20 UNF-2A	2.39	1.27	1.66	2.35	24 mm	15/16
FS65009-0606-01	3/8	9/16-18 UNF-2A	9/16-18 UNF-2A	2.35	1.30	1.67	2.36	24 mm	15/16
FS65009-0808-01	3/8	3/4-16 UNF-2A	3/4-16 UNF-2A	2.65	1.74	1.77	2.46	24 mm	15/16
FS65009-1010-01	5/8	7/8-14 UNF-2A	7/8-14 UNF-2A	2.87	1.36	2.00	2.77	29 mm	1-1/16
FS65009-1212-01	3/4	1 1/16-12 UN-2A	1 1/16-12 UN-2A	3.28	2.16	2.36	3.31	34 mm	1-1/4
FS65009-1616-01	1	1 5/16-12 UN-2A	1 5/16-12 UN-2A	3.67	2.35	2.60	3.68	43 mm	1-5/8

### Male SAE 37° x Female Pipe

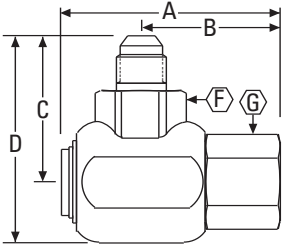

PART NUMBER	SWIVEL SIZE	CASING THREAD	SLEEVE THREAD	A	B	C	D	F	G
FS65016-0404-01	1/4	7/16-20 UNF-2A	1/4-18 NPTF	2.49	1.59	1.66	2.35	24 mm	15/16
FS65016-0606-01	3/8	9/16-18 UNF-2A	3/8-18 NPTF	2.49	1.58	1.67	2.36	24 mm	15/16
FS65016-0808-01	1/2	3/4-16 UNF-2A	1/2-14 NPTF	3.14	1.97	1.89	2.66	29 mm	1-1/16
FS65016-1212-01	3/4	1 1/16-12 UN-2A	3/4-14 NPTF	3.21	2.08	2.36	3.31	34 mm	1-5/16
FS65016-1616-01	1	1 5/16-12 UN-2A	1-11 1/2 NPTF	3.84	2.53	2.60	3.68	43 mm	1-5/8

### Male SAE O-Ring Boss x Male Pipe

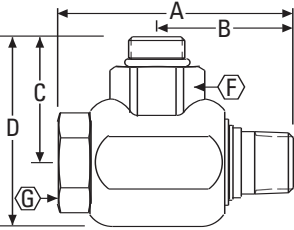

PART NUMBER	SWIVEL SIZE	CASING THREAD	SLEEVE THREAD	A	B	C	D	F	G
FS65013-0404-01	1/4	7/16-20 UNF-2A	1/4-18 NPTF	2.60	1.49	1.40	2.09	24 mm	15/16
FS65013-0606-01	3/8	9/16-18 UNF-2A	3/8-18 NPTF	2.53	1.48	1.41	2.09	24 mm	15/16
FS65013-0808-01	1/2	3/4-16 UNF-2A	1/2-14 NPTF	2.88	1.54	1.58	2.35	29 mm	1
FS65013-1212-01	3/4	1 1/16-12 UN-2A	3/4-14 NPTF	3.21	1.89	2.12	3.07	34 mm	1-1/4
FS65013-1616-01	1	1 5/16-12 UN-2A	1-11 1/2 NPTF	3.91	2.27	2.37	3.45	43 mm	1-5/8

### Male SAE O-Ring Boss x Female Pipe

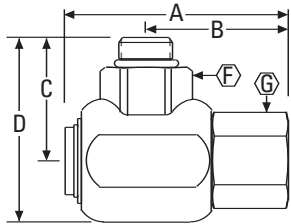

PART NUMBER	SWIVEL SIZE	CASING THREAD	SLEEVE THREAD	A	B	C	D	F	G
FS65017-0404-01	1/4	7/16-20 UNF-2A	1/4-18 NPTF	2.49	1.59	1.40	2.09	24 mm	15/16
FS65017-0606-01	3/8	9/16-18 UNF-2A	3/8-18 NPTF	2.49	1.58	1.41	2.09	24 mm	15/16
FS65017-0808-01	1/2	3/4-16 UNF-2A	1/2-14 NPTF	3.14	1.97	1.58	2.35	29 mm	1-1/16
FS65017-1212-01	3/4	1 1/16-12 UN-2A	3/4-14 NPTF	3.21	2.08	2.12	3.07	34 mm	1-5/16
FS65017-1616-01	1	1 5/16-12 UN-2A	1-11 1/2 NPTF	3.84	2.53	2.37	3.45	43 mm	1-5/8

### Male SAE O-Ring Boss x Male SAE 37°

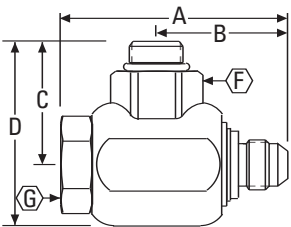

PART NUMBER	SWIVEL SIZE	CASING THREAD	SLEEVE THREAD	A	B	C	D	F	G
FS65020-0404-01	1/4	7/16-20 UNF-2A	7/16-20 UNF-2A	2.58	1.46	1.40	2.09	24 mm	15/16
FS65020-0606-01	3/8	9/16-18 UNF-2A	9/16-18 UNF-2A	2.51	1.46	1.41	2.09	24 mm	15/16
FS65020-0808-01	1/2	3/4-16 UNF-2A	3/4-16 UNF-2A	2.87	1.52	1.58	2.35	29 mm	1
FS65020-1212-01	3/4	1 1/16-12 UN-2A	1 1/16-12 UN-2A	3.31	1.99	2.12	3.07	34 mm	1-1/4
FS65020-1616-01	1	1 5/16-12 UN-2A	1 5/16-12 UN-2A	3.86	2.23	2.37	3.45	43 mm	1-5/8

### Male SAE O-Ring Boss x Male SAE O-Ring Boss

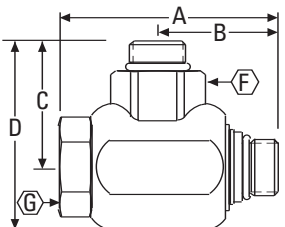

PART NUMBER	SWIVEL SIZE	CASING THREAD	SLEEVE THREAD	A	B	C	D	F	G
FS65023-0404-01	1/4	7/16-20 UNF-2A	7/16-20 UNF-2A	2.39	1.27	1.40	2.09	24 mm	15/16
FS65023-0606-01	3/8	9/16-18 UNF-2A	9/16-18 UNF-2A	2.35	1.30	1.41	2.09	24 mm	15/16
FS65023-0808-01	1/2	3/4-16 UNF-2A	3/4-16 UNF-2A	2.55	1.30	1.58	2.35	29 mm	1
FS65023-1212-01	3/4	1 1/16-12 UN-2A	1 1/16-12 UN-2A	3.28	2.16	2.12	3.07	34 mm	1-1/4
FS65023-1616-01	1	1 5/16-12 UN-2A	1 5/16-12 UN-2A	3.67	2.35	2.37	3.45	43 mm	1-5/8



**Female SAE O-Ring Boss x Male Pipe**

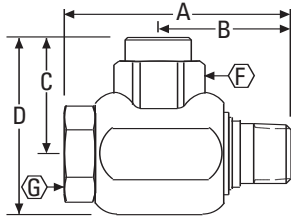

PART NUMBER	SWIVEL SIZE	CASING THREAD	SLEEVE THREAD	A	B	C	D	F	G
FS65014-0404-01	1/4	7/16-20 UNF-2B	1/4-18 NPTF	2.60	1.49	1.37	2.06	24 mm	15/16
FS65014-0606-01	3/8	9/16-18 UNF-2B	3/8-18 NPTF	2.53	1.48	1.38	2.06	24 mm	15/16
FS65014-0808-01	1/2	3/4-16 UNF-2B	1/2-14 NPTF	2.88	1.54	1.54	2.31	29 mm	1
FS65014-1212-01	3/4	1 1/16-12 UN-2B	3/4-14 NPTF	3.21	1.89	2.02	2.97	34 mm	1-1/4
FS65014-1616-01	1	1 5/16-12 UN-2B	1-11 1/2 NPTF	3.91	2.27	2.32	3.40	43 mm	1-5/8

**Female SAE O-Ring Boss x Female Pipe**

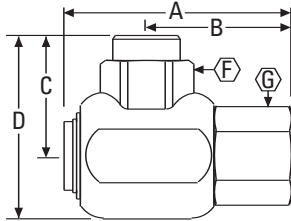

PART NUMBER	SWIVEL SIZE	CASING THREAD	SLEEVE THREAD	A	B	C	D	F	G
FS65018-0404-01	1/4	7/16-20 UNF-2B	1/4-18 NPTF	2.49	1.59	1.37	2.06	24 mm	15/16
FS65018-0606-01	3/8	9/16-18 UNF-2B	3/8-18 NPTF	2.49	1.58	1.38	2.06	24 mm	15/16
FS65018-0808-01	1/2	3/4-16 UNF-2B	1/2-14 NPTF	3.14	1.97	1.54	2.31	29 mm	1-1/16
FS65018-1212-01	3/4	1 1/16-12 UN-2B	3/4-14 NPTF	3.21	2.08	2.02	2.97	34 mm	1-5/16
FS65018-1616-01	1	1 5/16-12 UN-2B	1-11 1/2 NPTF	3.84	2.53	2.32	3.40	43 mm	1-5/8

**Female SAE O-Ring Boss x Male SAE 37°**

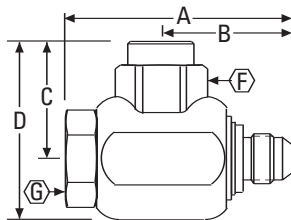

PART NUMBER	SWIVEL SIZE	CASING THREAD	SLEEVE THREAD	A	B	C	D	F	G
FS65021-0404-01	1/4	7/16-20 UNF-2B	7/16-20 UNF-2A	2.58	1.46	1.37	2.06	24 mm	15/16
FS65021-0606-01	3/8	9/16-18 UNF-2B	9/16-18 UNF-2A	2.51	1.46	1.38	2.06	24 mm	15/16
FS65021-0808-01	1/2	3/4-16 UNF-2B	3/4-16 UNF-2A	2.87	1.52	1.54	2.31	29 mm	1
FS65021-1212-01	3/4	1 1/16-12 UN-2B	1 1/16-12 UN-2A	3.31	1.99	2.02	2.97	34 mm	1-1/4
FS65021-1616-01	1	1 5/16-12 UN-2B	1 5/16-12 UN-2A	3.86	2.23	2.32	3.40	43 mm	1-5/8

**Female SAE O-Ring Boss x Male SAE O-Ring Boss**

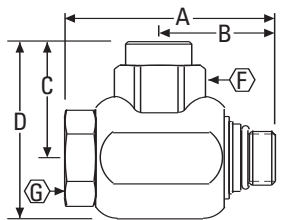

PART NUMBER	SWIVEL SIZE	CASING THREAD	SLEEVE THREAD	A	B	C	D	F	G
FS65024-0404-01	1/4	7/16-20 UNF-2B	7/16-20 UNF-2A	2.39	1.27	1.37	2.06	24 mm	15/16
FS65024-0606-01	3/8	9/16-18 UNF-2B	9/16-18 UNF-2A	2.35	1.30	1.38	2.06	24 mm	15/16
FS65024-0808-01	1/2	3/4-16 UNF-2B	3/4-16 UNF-2A	2.55	1.30	1.58	2.35	29 mm	1
FS65024-1212-01	3/4	1 1/16-12 UN-2B	1 1/16-12 UN-2A	3.28	2.16	2.02	2.97	34 mm	1-1/4
FS65024-1616-01	1	1 5/16-12 UN-2B	1 5/16-12 UN-2A	3.67	2.35	2.32	3.40	43 mm	1-5/8

**Male ORS x Male O-Ring Boss**

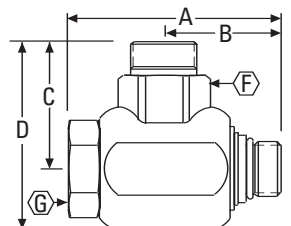

PART NUMBER	SWIVEL SIZE	CASING THREAD	SLEEVE THREAD	A	B	C	D	F	G
FS65025-0404-01	1/4	9/16-18 UN-2A	7/16-20 UNF-2A	2.39	1.27	1.44	2.13	24 mm	15/16
FS65025-0606-01	3/8	11/16-16 UNF-2A	9/16-18 UNF-2A	2.35	1.30	1.46	2.14	24 mm	15/16
FS65025-0808-01	1/2	13/16-16 UN-2A	3/4-16 UNF-2A	2.55	1.30	1.72	2.49	29 mm	1
FS65025-1212-01	3/4	1 3/16-12 UN-2A	1 1/16-12 UN-2A	3.28	2.16	2.25	3.20	34 mm	1-1/4
FS65025-1616-01	1	1 7/16-12 UN-2A	1 5/16-12 UN-2A	3.67	2.35	2.55	3.63	43 mm	1-5/8

# FS6500 Repair Kits

## FS65 Series Swivel Joint Repair Instructions

### Disassembly:

1. Remove the retaining ring from the sleeve gland.
2. By hand, gently remove the sleeve from the casing.
3. Remove all o-rings and backup rings from the glands (take care not to scratch the glands or bearing surfaces).
4. Thoroughly clean and inspect the bearing surfaces of the sleeve and casing and the seal glands of the sleeve. If these surfaces appear to be galled, scratched, or worn in any way, the assembly must be replaced.

### Assembly:

1. Assemble the seals to the sleeve as follows:
  - a. Lubricate the sleeve and o-rings with a silicon-based lubricant. The seal nearest the hex of the sleeve should be assembled first.
  - b. Assemble all four o-ring seals in the appropriate gland.
  - c. Lubricate the two backup rings.
  - d. Assemble the backup rings in the sealing glands. The backup rings should be positioned away from the pressure.

**Caution:** Backup rings must be expanded carefully to avoid damage. When in the gland, the skive-cut backup rings should be fully closed.

- e. The o-rings and back-up rings should be fully seated in the sealing glands.
2. After lubricating the casing bearing surface with a silicon-based lubricant, reassemble the sleeve to the casing.
3. Assemble the retaining rings in the gland formed by the sleeve and the casing face.

Replacement seal kit consists of four o-Rings, two backup rings, and one snap ring.

SEAL TYPE SWIVEL SIZE	SEAL KIT PART NUMBERS			
	1/4" & 3/8"	1/2" & 5/8"	3/4"	1"
Buna-N (Code -01)	FS65-01013-01	FS65-01018-01	FS65-01019-01	FS65-01020-16-01
EPR (Code -04)	FS65-01013-04	FS65-01018-04	FS65-01019-04	FS65-01020-16-04
Viton™ (Code -06)	FS65-01013-06	FS65-01018-06	FS65-01019-06	FS65-01020-16-06

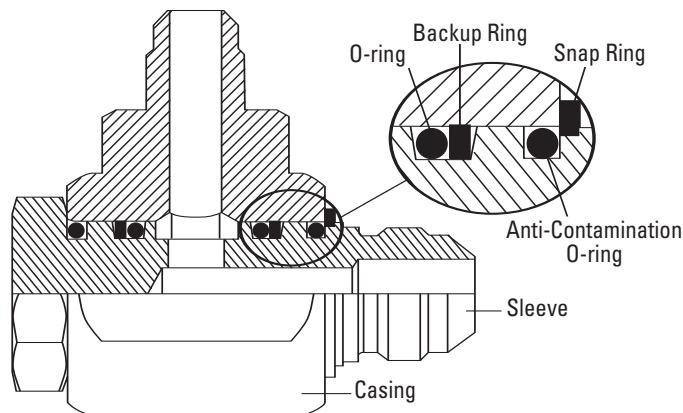

# Swivel Joints

## BD5500

The BD5500 Series industrial Swivel Joint's pressure balanced design distributes pressure evenly through the body of the joint which eliminates axial loading of the sleeve. This pressure balanced design allows the BD5500 Series Swivel Joint to turn with very low torque even under pressures up to 3000 psi.

Available sizes: -20 and -24  
 Operating Pressure: 3000 psi.

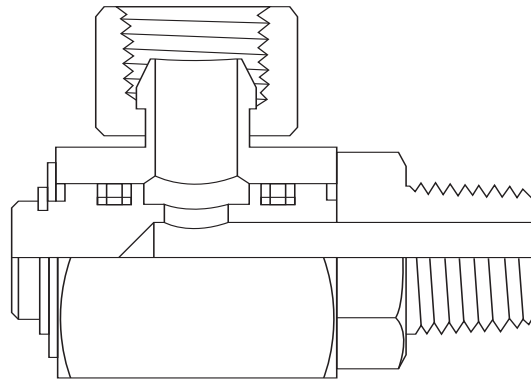

### Torque vs Pressure

This chart shows the low torque required to rotate the BD5500 Series Swivel Joint while under pressure. This data is based on actual testing of production assemblies.

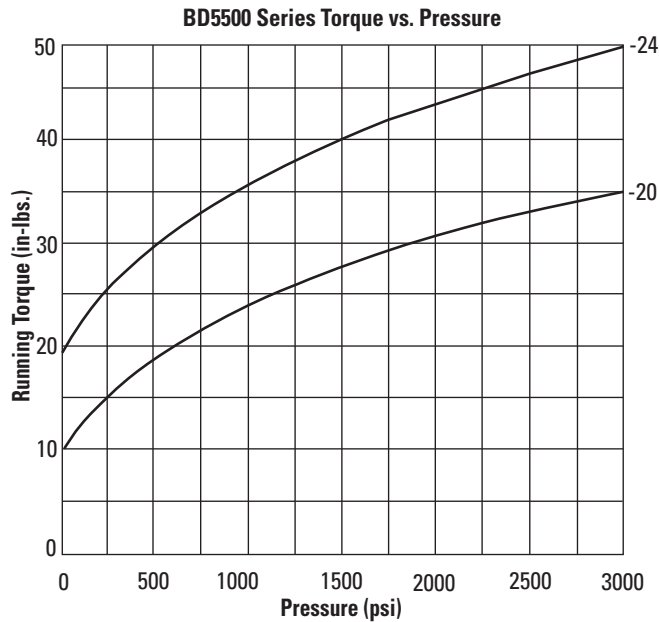

### Pressure Drop vs Flow

These test results for pressure drop at various flow rates were made with MIL-H-5606A oil at temperatures (+70°F to +80°F) on production assemblies.

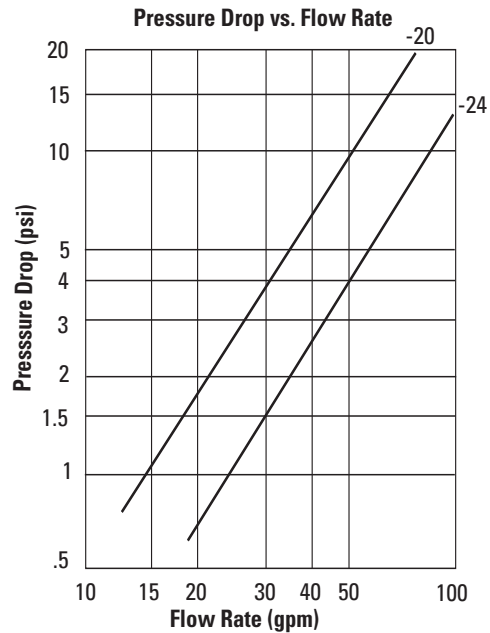

### Seal Options:

SUFFIX NUMBER	MATERIAL	STANDARD	OPTIONAL
-01	Buna-N	X	
-04	EPR		X
-06	Viton		X

### Pressure Rating for BD5500:

SIZE	OPERATING PRESSURE
All Sizes	25 in./Hg vacuum to 3000 psi

### Female Pipe Swivel to Male Pipe

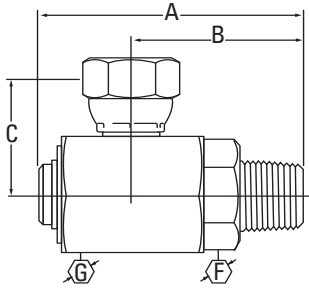

PART NUMBER	NOM. SIZE	CASING THREAD	SLEEVE THREAD	A	B	C	F	G
BD55000-2020-01	1 1/4"	1 1/4-11 1/2 NPSM	1 1/4-11 1/2 NPTF	4.88	3.16	2.00	1.75	2.50
BD55000-2424-01	1 1/2"	1 1/2-11 1/2 NPSM	1 1/2-11 1/2 NPTF	5.30	3.50	2.25	2.12	3.00

### Female Pipe Swivel to Male SAE 37°

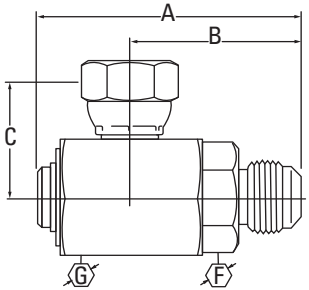

PART NUMBER	NOM. SIZE	CASING THREAD	SLEEVE THREAD	A	B	C	F	G
BD55001-2020-01	1 1/4"	1 1/4-11 1/2 NPSM	5/8-12UN-2A	4.88	3.16	2.00	1.75	2.50
BD55001-2424-01	1 1/2"	1 1/2-11 1/2 NPSM	7/8-12UN-2A	5.30	3.50	2.25	2.12	3.00

### Female Pipe Swivel to Male SAE O-Ring

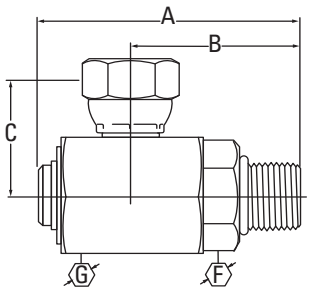

PART NUMBER	NOM. SIZE	CASING THREAD	SLEEVE THREAD	A	B	C	F	G
BD55004-2020-01	1 1/4"	1 1/4-11 1/2 NPSM	5/8-12UN-2A	4.60	2.89	2.00	1.88	2.50
BD55004-2424-01	1 1/2"	1 1/2-11 1/2 NPSM	7/8-12UN-2A	5.06	3.27	2.25	2.12	3.00

### Male SAE 37° to Male Pipe

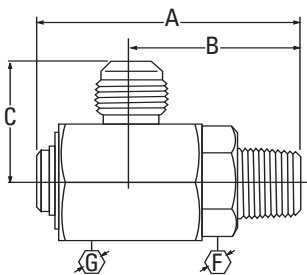

PART NUMBER	NOM. SIZE	CASING THREAD	SLEEVE THREAD	A	B	C	F	G
BD55005-2020-01	1 1/4"	5/8-12UN-2A	1 1/4-11 1/2 NPTF	4.88	3.16	2.20	1.75	2.50
BD55005-2424-01	1 1/2"	7/8-12UN-2A	1 1/2-11 1/2 NPTF	5.30	3.50	2.57	2.12	3.00

### Male SAE 37° to Male SAE 37°

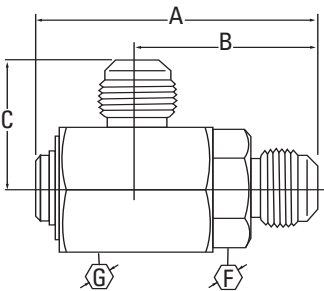

PART NUMBER	NOM. SIZE	CASING THREAD	SLEEVE THREAD	A	B	C	F	G
BD55009-2020-01	1 1/4"	5/8-12UN-2A	5/8-12UN-2A	4.88	3.16	2.20	1.75	2.50
BD55009-2424-01	1 1/2"	7/8-12UN-2A	7/8-12UN-2A	5.30	3.50	2.57	2.12	3.00

### Female Pipe Swivel to Female Pipe

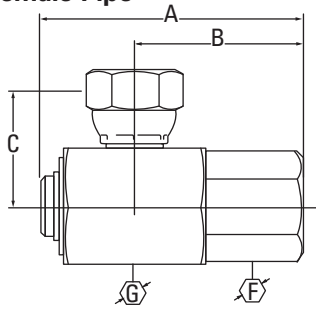

PART NUMBER	NOM. SIZE	CASING THREAD	SLEEVE THREAD	A	B	C	(F)	(G)
BD55011-2020-01	1 1/4"	1 1/4-11 1/2NPSM	1 1/4-11 1/2NPTF	4.50	2.78	2.00	2.00	2.50
BD55011-2424-01	1 1/2"	1 1/2-11 1/2NPSM	1 1/2-11 1/2NPTF	4.62	2.82	2.25	2.38	3.00

### Male Pipe to Male Pipe

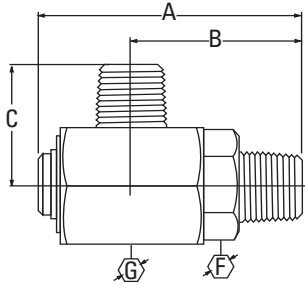

PART NUMBER	NOM. SIZE	CASING THREAD	SLEEVE THREAD	A	B	C	(F)	(G)
BD55012-2020-01	1 1/4"	1 1/4-11 1/2NPTF	1 1/4-11 1/2NPTF	4.88	3.16	2.27	1.75	2.50
BD55012-2424-01	1 1/2"	1 1/2-11 1/2NPTF	1 1/2-11 1/2NPTF	5.30	3.50	2.54	2.12	3.00

### Female Pipe Fixed to Male Pipe

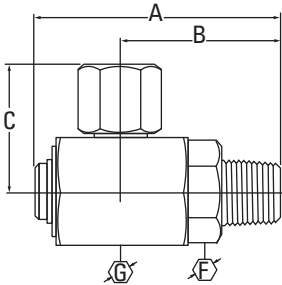

PART NUMBER	NOM. SIZE	CASING THREAD	SLEEVE THREAD	A	B	C	(F)	(G)
BD55014-2020-01	1 1/4"	1 1/4-11 1/2NPTF	1 1/4-11 1/2NPTF	4.88	3.16	2.77	1.75	2.50
BD55014-2424-01	1 1/2"	1 1/2-11 1/2NPTF	1 1/2-11 1/2NPTF	5.30	3.50	3.02	2.12	3.00

### Female Pipe Fixed to Female Pipe

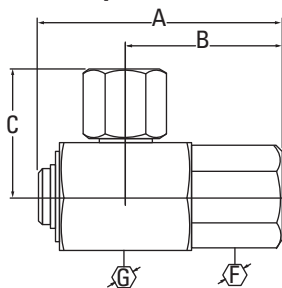

PART NUMBER	NOM. SIZE	CASING THREAD	SLEEVE THREAD	A	B	C	(F)	(G)
BD55015-2020-01	1 1/4"	1 1/4-11 1/2NPTF	1 1/4-11 1/2NPTF	4.50	2.78	2.77	2.00	2.50
BD55015-2424-01	1 1/2"	1 1/2-11 1/2NPTF	1 1/2-11 1/2NPTF	4.62	2.82	3.02	2.38	3.00

### Male SAE 37° to Male SAE O-Ring

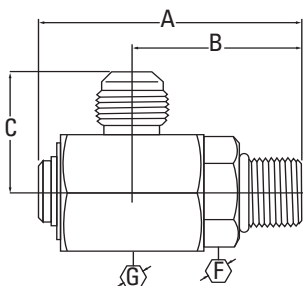

PART NUMBER	NOM. SIZE	CASING THREAD	SLEEVE THREAD	A	B	C	(F)	(G)
BD55021-2020-01	1 1/4"	1 5/8-12UN-2A	1 5/8-12UN-2A	4.60	2.89	2.20	1.88	2.50
BD55021-2424-01	1 1/2"	1 7/8-12UN-2A	1 7/8-12UN-2A	5.06	3.27	2.57	2.12	3.00

**Female Pipe Fixed to Male SAE 37°**

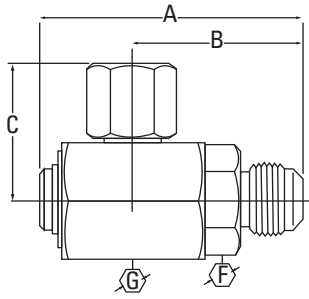

PART NUMBER	NOM. SIZE	CASING THREAD	SLEEVE THREAD	A	B	C	F	G
BD55029-2020-01	1 1/4"	1 1/4-11 1/2NPTF	1 5/8-12UN-2A	4.88	3.16	2.77	1.75	2.50
BD55029-2424-01	1 1/2"	1 1/2-11 1/2NPTF	1 7/8-12UN-2A	5.30	3.50	3.02	2.12	3.00

**Female Pipe Fixed to Male SAE O-Ring**

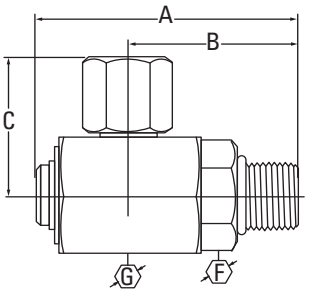

PART NUMBER	NOM. SIZE	CASING THREAD	SLEEVE THREAD	A	B	C	F	G
BD55031-2020-01	1 1/4"	1 1/4-11 1/2NPTF	1 5/8-12UN-2A	4.60	2.89	2.77	1.88	2.50
BD55031-2424-01	1 1/2"	1 1/2-11 1/2NPTF	1 7/8-12UN-2A	5.06	3.27	3.02	2.12	3.00

**BD5500  
Repair Kits**

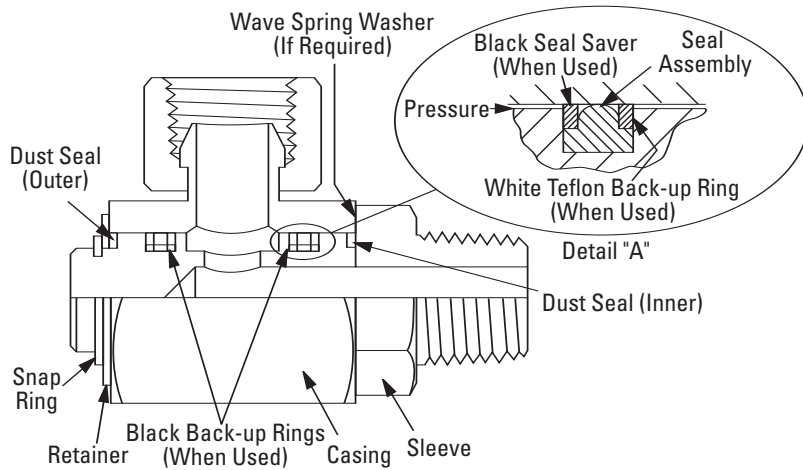

Replacement seal kit consists of (2) TRI-RING SEAL™ assemblies, (2) dust seals, (1) washer and (1) snap ring.

SEAL TYPE NOMINAL SIZE	SEAL KIT PART NUMBERS						
	1/4"	3/8"	1/2"	3/4"	1"	1 1/4"	1 1/2"
Buna-N (Code -01)	10-62017-01	10-62018-01	10-62019-01	10-62020-01	10-62021-01	10-62022-01	10-62023-01
EPR (Code -04)	10-62017-04	10-62018-04	10-62019-04	10-62020-04	10-62021-04	10-62022-04	10-62023-04
Viton (Code -06)	10-62017-06	10-62018-06	10-62019-06	10-62020-06	10-62021-06	10-62022-06	10-62023-06



# Swivel Joints FS5900

The FS5900 Series Swivel Joint is designed for 25 in./Hg vacuum to 5000 psi operating pressure service made possible by advanced design needle bearings and seals. In addition to high pressures, the FS5900 series provides full fluid flow with minimal pressure drop.

The excellent corrosion resistance of the FS5900 series is made possible by the plated steel components.

Both field and laboratory testing have proven the FS5900 Series Swivel Joints can withstand greater side loads than conventional swivel joints. High pressure impulse life has also been improved.

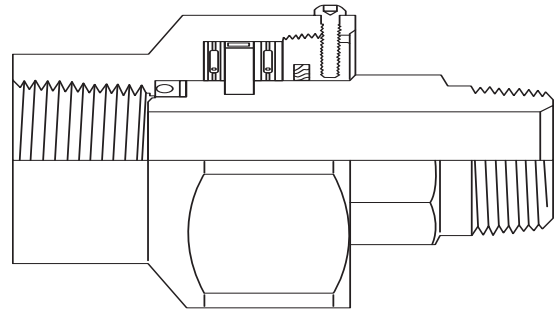

## Torque vs Pressure

Testing to determine the torque required to rotate an FS5900 Series Swivel Joint was conducted on actual production assemblies.

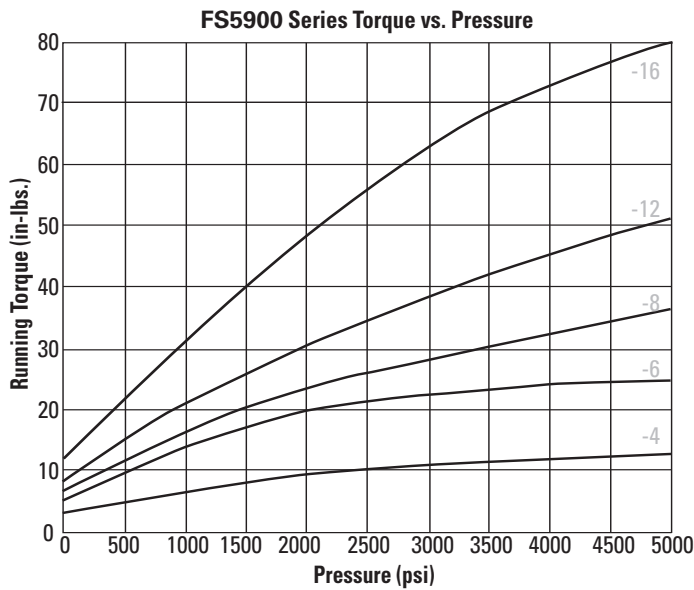

## Pressure Drop vs Flow

Testing for pressure drop at various flow rates was conducted with MIL-H-5606 hydraulic oil at temperatures (+70°F to +80°F).

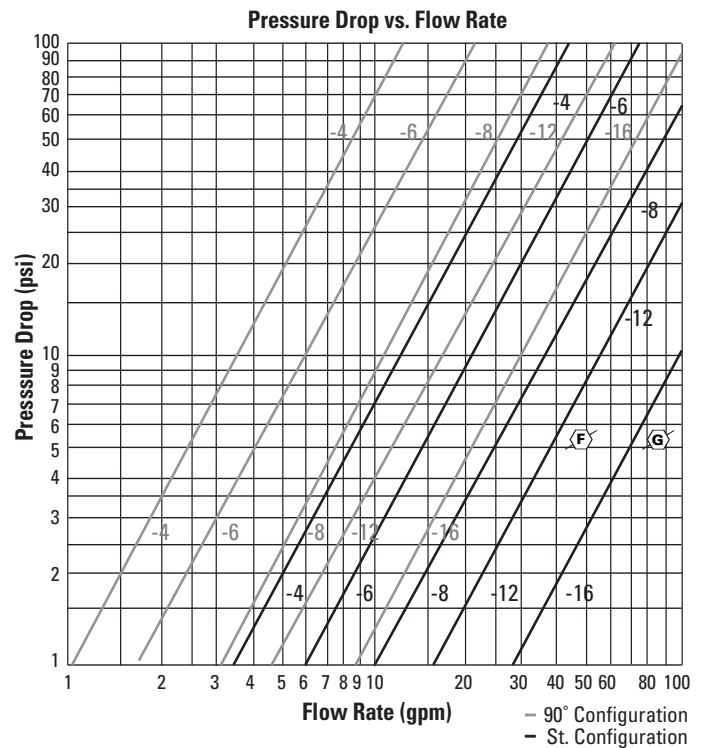

## Seal Options:

### O-Ring Seals (1/4 inch size only)

SUFFIX NUMBER	MATERIAL	TEMPERATURE RANGE	STANDARD	OPTIONAL
-01	Buna-N	-40°F to 250°F	X	
-04	EPR	-60°F to 300°F		X
-06	Viton	-20°F to 300°F		X

### U-Cup Seals (3/8" through 1" sizes)

SUFFIX NUMBER	MATERIAL	TEMPERATURE RANGE	STANDARD	OPTIONAL
-75	Hytrel/Buna	-20°F to 250°F	X	
-74	Urethane/Buna	-40°F to 180°F		X

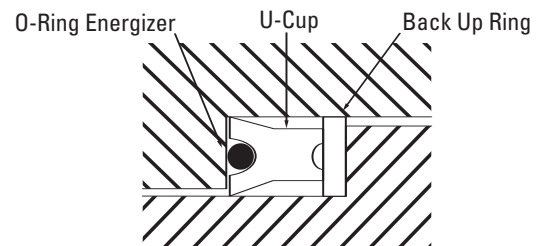
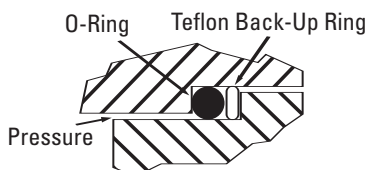

**Female Pipe to Female Pipe**  
\*1000 psi operating pressure

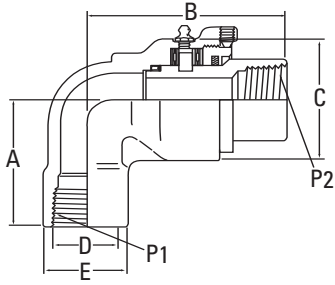

PART NUMBER	NOM. SIZE	THREAD P1	THREAD P2	A	B	C	D	E
FS59000-1616-01*1"		1-11 <sup>1</sup> / <sub>2</sub> NPTF	1-11 <sup>1</sup> / <sub>2</sub> NPTF	2.50	3.87	2.41	1.62	1.91

**(Straight) Female Pipe to Female Pipe**

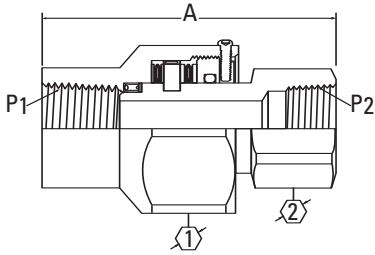

PART NUMBER	NOM. SIZE	THREAD P1	THREAD P2	A	B	C	①	②
FS59001-1616-75	1"	1-11 <sup>1</sup> / <sub>2</sub> NPTF	1-11 <sup>1</sup> / <sub>2</sub> NPTF	4.31			2.50	1.62

**Female Pipe to Male Pipe**

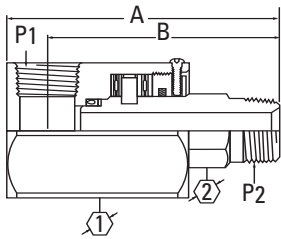

PART NUMBER	NOM. SIZE	THREAD P1	THREAD P2	A	B	①	②
FS59002-0404-01	1/4"	1/4-18 NPTF	1/4-18 NPTF	3.20	2.82	1.19	.56
FS59002-0606-75	3/8"	3/8-18 NPTF	3/8-18 NPTF	3.67	3.21	1.88	.94
FS59002-0808-75	1/2"	1/2-14 NPTF	1/2-14 NPTF	4.01	3.45	1.88	.94
FS59002-1212-75	3/4"	3/4-14 NPTF	3/4-14 NPTF	4.32	3.64	2.12	1.19
FS59002-1616-75	1"	1-11 <sup>1</sup> / <sub>2</sub> NPTF	1-11 <sup>1</sup> / <sub>2</sub> NPTF	4.88	4.08	2.50	1.44

**Female Pipe to Male SAE 37°**

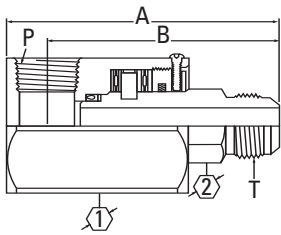

PART NUMBER	NOM. SIZE	THREAD P1	THREAD P2	A	B	①	②
FS59003-0405-01	1/4"	1/4-18 NPTF	1/2-20 UNF-2A	3.19	2.81	1.19	.56
FS59003-0608-75	3/8"	3/8-18 NPTF	3/4-16 UNF-2A	3.77	3.31	1.88	.94
FS59003-0810-75	1/2"	1/2-14 NPTF	7/8-14 UNF-2A	4.00	3.44	1.88	.94
FS59003-1212-75	3/4"	3/4-14 NPTF	1 <sup>1</sup> / <sub>16</sub> -12 UN-2A	4.43	3.75	2.12	1.19
FS59003-1616-75	1"	1-11 <sup>1</sup> / <sub>2</sub> NPTF	1 <sup>5</sup> / <sub>16</sub> -12 UN-2A	4.85	4.05	2.50	1.44

**Female Pipe to Male Pipe**

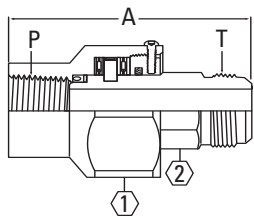

PART NUMBER	NOM. SIZE	THREAD P1	THREAD P2	A	B	①	②
FS59004-0404-01	1/4"	1/4-18 NPTF	1/4-18 NPTF	3.23		1.19	.56
FS59004-0606-75	3/8"	3/8-18 NPTF	3/8-18 NPTF	3.62		1.88	.94
FS59004-0808-75	1/2"	1/2-14 NPTF	1/2-14 NPTF	3.97		1.88	.94
FS59004-1212-75	3/4"	3/4-14 NPTF	3/4-14 NPTF	4.04		2.12	1.19
FS59004-1616-75	1"	1-11 <sup>1</sup> / <sub>2</sub> NPTF	1-11 <sup>1</sup> / <sub>2</sub> NPTF	4.57		2.50	1.44

### Female Pipe to Male SAE 37°

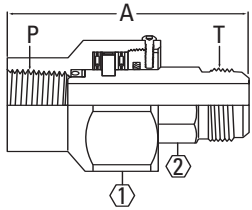

PART NUMBER	NOM. SIZE	THREAD P1	THREAD P2	A	B	①	②
FS59005-0405-01	1/4"	1/4-18 NPTF	1/2-20 UNF-2A	3.22		1.19	.56
FS59005-0608-75	3/8"	3/8-18 NPTF	3/4-16 UNF-2A	3.72		1.88	.94
FS59005-0810-75	1/2"	1/2-14 NPTF	7/8-14 UNF-2A	3.96		1.88	.94
FS59005-1212-75	3/4"	3/4-14 NPTF	1 <sup>1</sup> / <sub>16</sub> -12 UN-2A	4.15		2.12	1.19
FS59005-1616-75	1"	1-11 <sup>1</sup> / <sub>2</sub> NPTF	1 <sup>5</sup> / <sub>16</sub> -12 UN-2A	4.54		2.50	1.44

### Male SAE 37° to Female SAE 37°

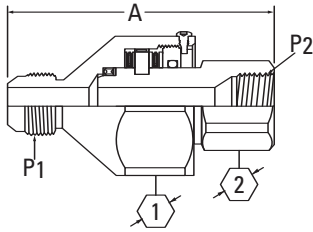

PART NUMBER	NOM. SIZE	THREAD P1	THREAD P2	A	B	①	②
FS59006-0505-01	1/4"	1/2-20 UNF-2A	1/2-20 UNF-2B	2.98		1.19	.62
FS59006-0808-75	3/8"	3/4-16 UNF-2A	3/4-16 UNF-2B	3.48		1.88	.94
FS59006-1010-75	1/2"	7/8-14 UNF-2A	7/8-14 UNF-2B	3.74		1.88	1.00
FS59006-1212-75	3/4"	1 <sup>1</sup> / <sub>16</sub> -12 UN-2A	1 <sup>1</sup> / <sub>16</sub> -12 UN-2B	3.88		2.12	1.25
FS59006-1616-75	1"	1 <sup>5</sup> / <sub>16</sub> -12 UN-2A	1 <sup>5</sup> / <sub>16</sub> -12 UN-2B	4.03		2.50	1.50

### Male SAE 37° to Female SAE 37°

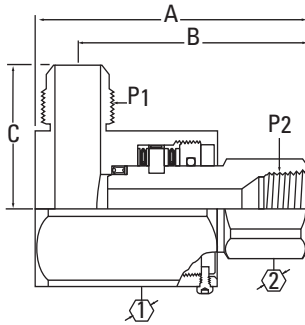

PART NUMBER	NOM. SIZE	THREAD P1	THREAD P2	A	B	C	①	②
FS59011-0505-01	1/4"	1/2-20 UNF-2A	1/2-20 UNF-2B	2.69	2.41	1.16	1.19	.62
FS59011-0808-75	3/8"	3/4-16 UNF-2A	3/4-16 UNF-2B	3.08	2.73	1.59	1.88	.94
FS59011-1010-75	1/2"	7/8-14 UNF-2A	7/8-14 UNF-2B	3.46	3.06	1.70	1.88	1.00
FS59011-1212-75	3/4"	1 <sup>1</sup> / <sub>16</sub> -12 UN-2A	1 <sup>1</sup> / <sub>16</sub> -12 UN-2B	3.58	3.08	1.93	2.12	1.25
FS59011-1616-75	1"	1 <sup>5</sup> / <sub>16</sub> -12 UN-2A	1 <sup>5</sup> / <sub>16</sub> -12 UN-2B	3.91	3.29	2.16	2.50	1.50

## FS5900 Repair Kits

The FS5900 Series Swivel Joints are easily field repaired. Two different kits are available. The choice of which kit to use is dependent upon the extent of repairs necessary.

FF974 Kits include: a replacement seal assembly, back-up rings and a new dust seal.

FF975 Kits include: a replacement seal assembly, back-up rings, a new dust seal and two sets of bearings and races.

For FS59000-1616-01 order repair kit FF028-16-01 includes: a replacement seal assembly, back-up rings and a new dust seal.

### To order FF974 and FF975 Kits: **FF974- 08- 75**

Kit Base Number \_\_\_\_\_

Joint Size (Swivel Joint Nominal size 1/2") \_\_\_\_\_

Seal Material Code \_\_\_\_\_

(see Seal Options chart on page 15)

NOTE: Use swivel joint nominal size when ordering kits, not port size.





**Eaton**  
14615 Lone Oak Road  
Eden Prairie, MN 55344  
USA  
Tel: 952 937-9800  
Fax: 952 974-7722  
[www.hydraulics.eaton.com](http://www.hydraulics.eaton.com)

**Eaton**  
20 Rosamond Road  
Footscray  
Victoria 3011  
Australia  
Tel: (61) 3 9319 8222  
Fax: (61) 3 9318 5714

**Eaton**  
Dr.-Reckeweg-Str. 1  
D-76532 Baden-Baden  
Germany  
Tel: (49) 7221 682-0  
Fax: (49) 7221 682-788



**Hydraulics**

© 2004 Eaton Corporation  
All Rights Reserved  
Printed in USA  
Document No. E-MESW-MC001-E  
Supersedes JB90A  
June 2004